

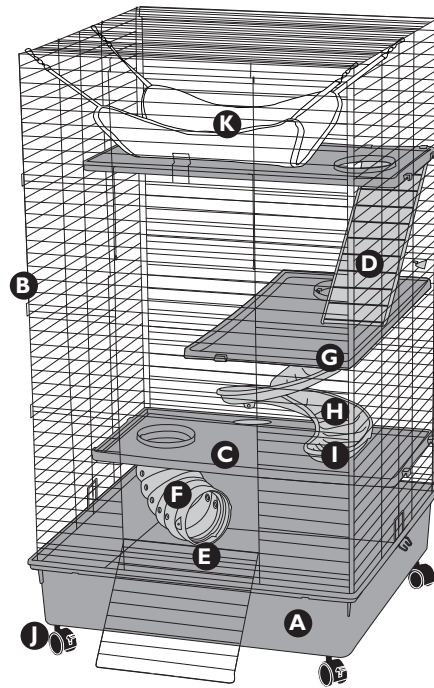

My First Home Deluxe Multi-Level

Home measures 24" L x 24" W x 41.5" H
Assembly Instructions

DESCRIPTION	MATERIAL NO.	UPC
My First Home Deluxe Multi-Level	100079097	045125602487



Important:

Carefully Unpack and Sort All Components on the Parts List

QTY.	KEY	DESCRIPTION
1	A	Plastic Base
1	B	Wire Panels Set
3	C	Comfort Shelf
1	D	Safety Ramp
1	E	Fun-nel Ring
1	F	Elbow Tube
1	G	Spiral Connector Kit
2	H	Spiral Curve
1	I	Spiral End
1	J	Caster Set
1	K	Hammock

If your new pet home has experienced damage during shipping, please do not return your cage to the store.

Our Customer Service Department is available to help with any problems. Our Toll-Free Number (within the USA and Canada only) is 800-255-4527, Monday - Friday from 8:00 a.m. to 4:00 p.m. (Central Standard Time).

SAVE YOUR INSTRUCTIONS FOR FUTURE REFERENCE

Manufactured by: KAYTEE Products, Inc., Chilton, WI 53014 USA
©2017 KAYTEE Products, Inc.
Made in the USA of US and Imported Parts
Kaytee and Kaytee with design are registered trademarks of Kaytee Products, Inc.
For more information on bird and small animal products, visit us at kaytee.com

PP1006117

STEP 1 Base

Turn the Plastic Base (A) upside down so that the bottom is facing upward.

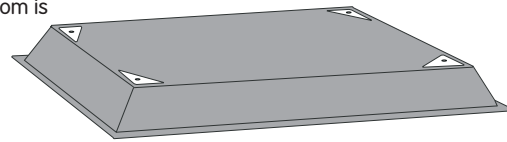

STEP 2 Attach Casters to Base

One at a time, align a Caster (L) on one of the four corners of the Base (A). Attach each Caster simply by pushing in. (no tools required)

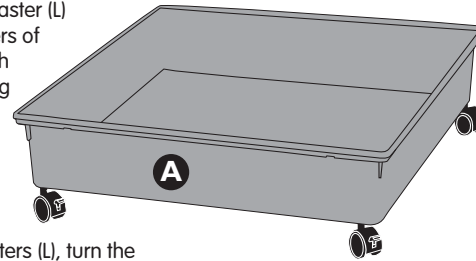

After attaching all 4 Casters (L), turn the Base upright and set aside.

STEP 3 Unwrap Wire Panel Set

Unwrap the Wire Panels (B) and lay on a flat surface with the front doorway facing upward.

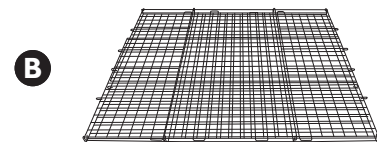

STEP 4 Unfold Wire Panel Set

Carefully unfold the Front, Back, and Side Panels.

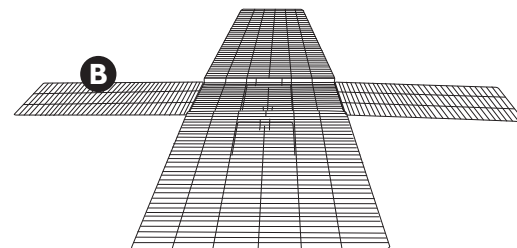

STEP 5 Lock Side Panels to Back Panel

Lock the Right and Left Side Panels onto the Back Panel. Snap the wire hook through the wire loop.



Special Note: If the wire hooks have become bent during shipping, carefully pry them open to fit into the side panel wire loops.

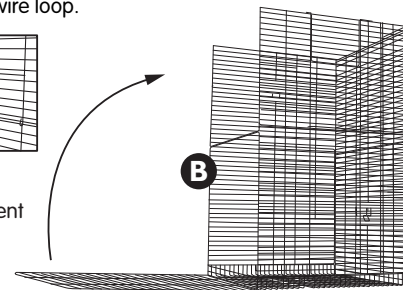

STEP 6 Lock Panels Into Base

Place the Assembled Wire Set (B) into the Plastic Base (A), with the doorway facing front.

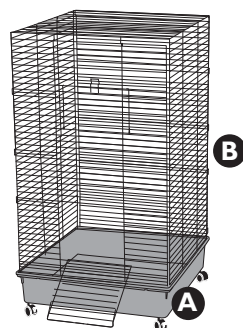
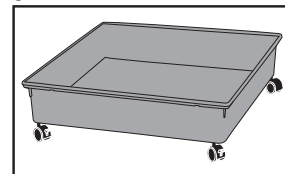

STEP 7 Attach Elbow Tube

Snap together the two halves of the Elbow Tube (F). Snap the Tube Connector Ring (E) onto one end. Insert the opposite end of the Elbow Tube into the bottom of the Comfort Shelf (C).

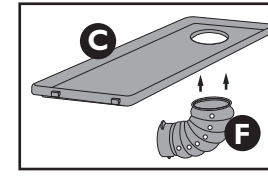
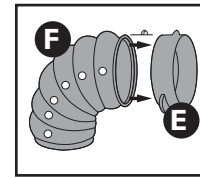
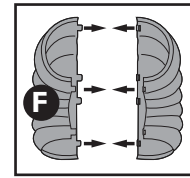

STEP 8 Attach Bottom Comfort Shelf

Position the assembled Comfort Shelf (C) with Elbow Tube (F) in the back side of the home, on the 6th full-length bar from the bottom. Press down so that the Shelf locks firmly into place.

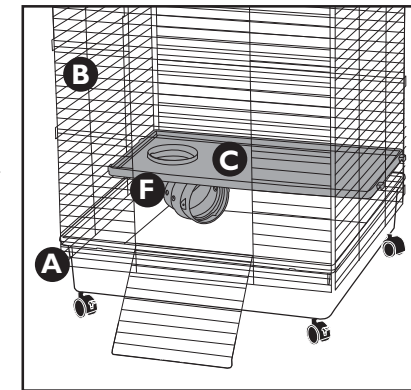

STEP 9 Assemble Spiral Curve

Connect the three sections of the Spiral (G-I) according to the illustration. The spiral twists and locks into place on the bottom of a Comfort Shelf (C).

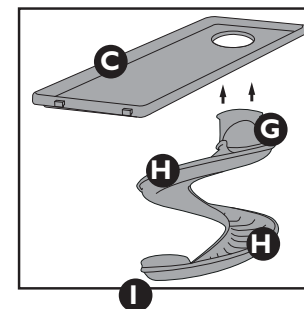
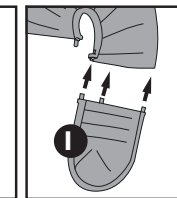
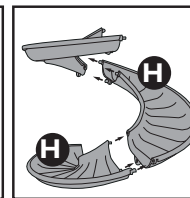
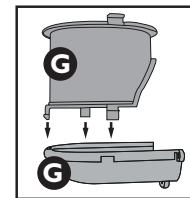

STEP 10 Attach Comfort Shelf

Position the assembled Comfort Shelf with Spiral on the right side of the home with the spiral in the back, on the 19th full-length bar up from the bottom. Press down so that the shelf locks firmly into place.

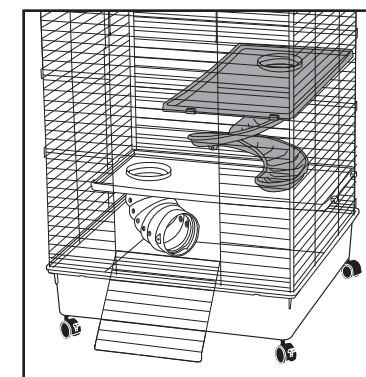

STEP 11 Attach Safety Ramp

Attach the Safety Ramp (D) to a Comfort Shelf by clipping the tabs on the Ramp to the edge of the Comfort Shelf. Position the Ramp so that it comes under the opening in the Comfort Shelf.

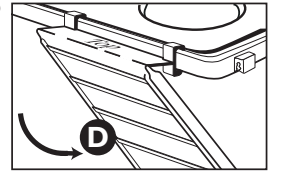

STEP 12 Attach Top Comfort Shelf

Position the assembled Comfort Shelf with Ramp on the back side of the home with the Ramp on the right, on the 11th full-length bar down from the top. Press down so that the Shelf locks firmly into place.

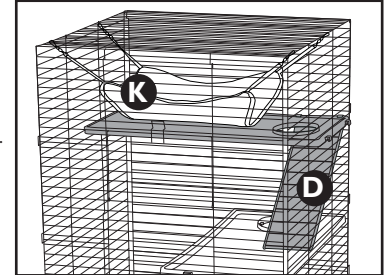

Attach Hammock (K) by Clipping the 4 hooks to the Wire Top of the home.

STEP 13 Attach Side Latches

Be sure to snap Latches under the lip on the Plastic Base to secure the cage to the Base (A).

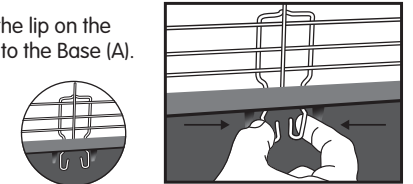

SAFETY

To safely secure your pet inside the home, firmly press the "Z-Lock" Latch behind the 2nd horizontal cage bar above the door opening.

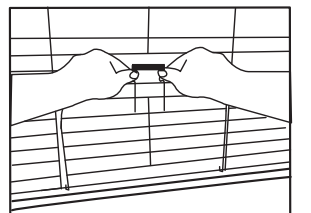

CLEANING

To clean your pet's home, simply unsnap the Wire Panel Set (A) from the Plastic Base (B). Empty and wash the Plastic Base or spray with Kaytee® Clean Cage (Item # 63062), wipe dry, refill with fresh bedding material, and replace the Wire Panel Set onto the Plastic Base. Kaytee® Clean Cage neutralizes odors, safely cleans surfaces, and is non-toxic to all pets.