

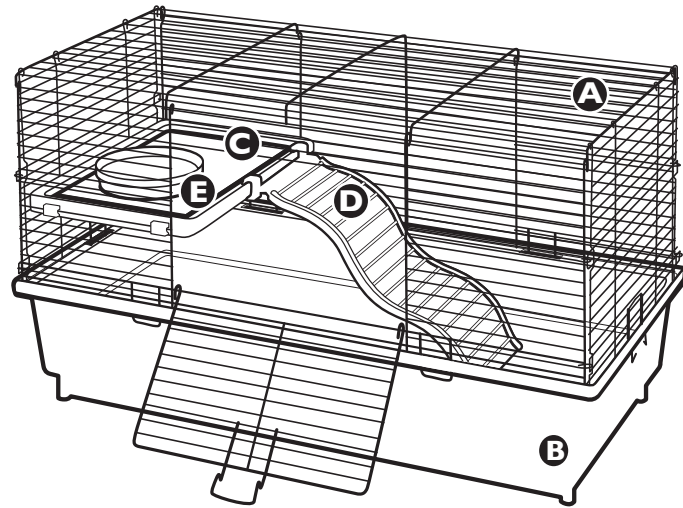

My First Home Pet Rat 24" x 12" Assembly Instructions

DESCRIPTION	MATERIAL NO.	UPC
MFH Pet Rat 24" x 12"	I00513100	045125502169



Important:

Carefully Unpack and Sort All Components on the Parts List

QTY.	KEY	DESCRIPTION
1	A	Wire Panel Set
1	B	Plastic Base
1	C	Comfort Shelf
1	D	Safety Ramp
1	E	Food Dish

If your new pet home has experienced damage during shipping, please do not return your cage to the store.

Our Customer Service Department is available to help with any problems. Our Toll-Free Number (within the USA and Canada only) is 800-255-4527, Monday - Friday from 8:00 a.m. to 4:00 p.m. (Central Standard Time).

SAVE YOUR INSTRUCTIONS FOR FUTURE REFERENCE

Manufactured by: KAYTEE Products, Inc., Chilton, WI 53014 USA
©2016 KAYTEE Products, Inc.
Made in the USA of US and Imported Parts
Kaytee and Kaytee with design are registered trademarks of Kaytee Products, Inc.
For more information on bird and small animal products, visit us at: kaytee.com

PP1004816

STEP 1 Unwrap Wire Panel Set

Unwrap the Wire Panels (A) and lay on a flat surface with the doorway facing upward.

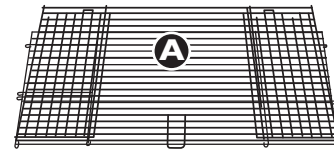

STEP 2 Unfold Wire Panel Set

Carefully unfold the Front, Back, and Side panels.

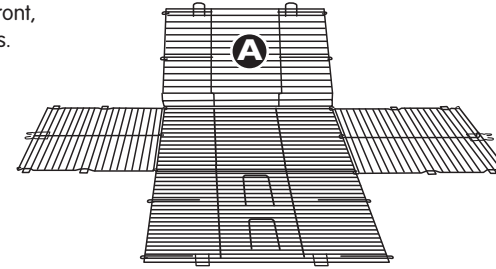

STEP 3 Lock Side Panels to Back Panel

Lock the Right and Left Side Panels onto the Back Panel.

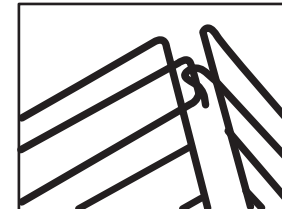

Snap the wire hook through the wire loop.

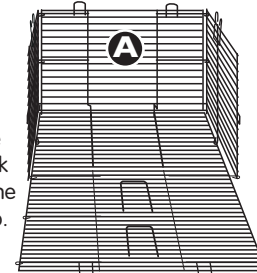

STEP 4 Lock Front Panel to Side Panels

Next lock the Front Panel onto the Side Panels.

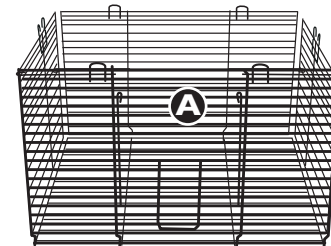

Special Note: If the wire hooks have become bent during shipping, carefully pry them open to fit into the side panel wire loops.

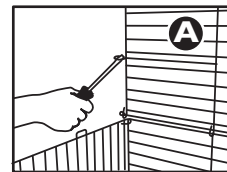

STEP 5 Put in Comfort Shelf

Flip wire set to upright position. Insert Comfort Shelf (C) through door opening and position Comfort Shelf in place on the left side of the cage on the 8th bar up from the bottom. Snap Comfort Shelf into place on wire.

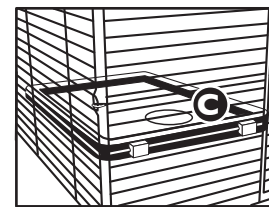

STEP 6 Lock Wire Panels into Base

Place the wire cage on top of the Plastic Base (B), making sure to insert the wire tabs into the slots in the base.

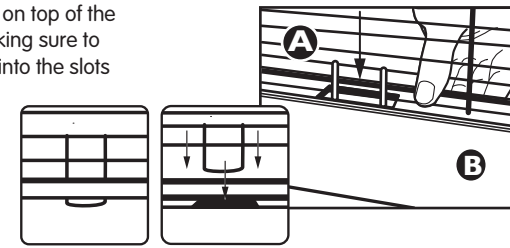

STEP 7 Secure Wire to Base

Line up the loops at the bottom of the Wire Panel Set (A) to the holes provided on the Plastic Base (B).

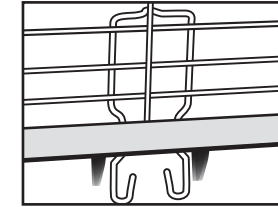

STEP 8 Clip on Safety Ramp

Clip the Safety Ramp (D) to the Comfort Shelf (C) by snapping the two prongs on the Ramp to the edge of the Comfort Shelf.

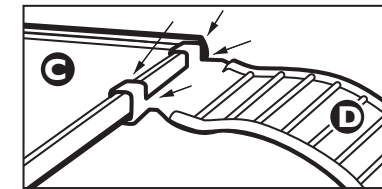

STEP 9 Insert Food Dish

Place the Food Dish (E) in the opening on the Comfort Shelf.

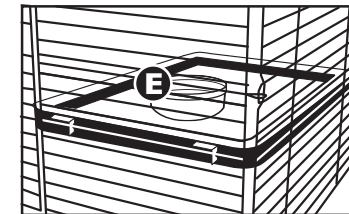

SAFETY

To safely secure your pet inside the home, firmly press the "Z-Lock" Latch behind the 2nd horizontal cage bar above the door opening.

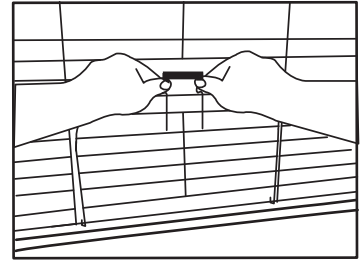

CLEANING

Pinch Bunny Ear latches on each side of the Wire Set (A) and lift the entire Wire Set off the Plastic Base (B). Set the assembly on a flat surface while you empty the Plastic Base (B). Empty and wash the Plastic Base (B) with soap and water or spray with Kaytee® Clean Cage (Item #100079553) (sold separately), and wipe dry. Kaytee® Clean Cage neutralizes odors, safely cleans surfaces and is non-toxic to all pets.

